

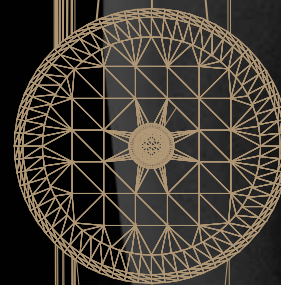

WELCOME TO
THE **WORLD OF PENT**
LUXURY FITNESS
EQUIPMENT



04
About us

17
COLMIA™

23
LOVA™

29
MOXA™

35
LESNA™

39
BANKA™

45
SCALA™

49
RAXA™

53
Accessories

59
MULTI SET

64
Collection Black Ash

69
Materials

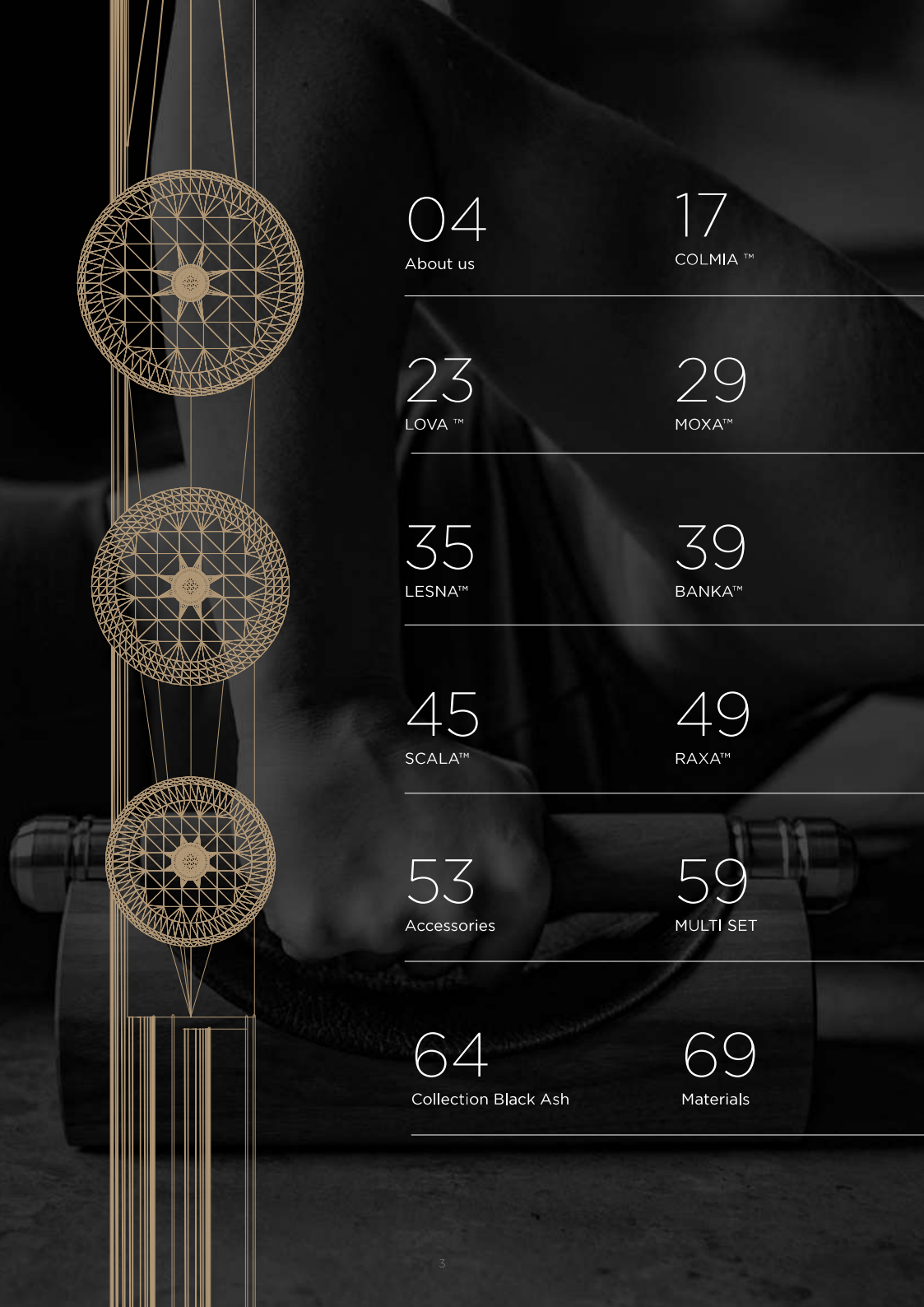



*PENT.
is not just
a fitness equipment,
but also a beautiful
piece of furniture.*



LUXURY FITNESS EQUIPMENT PRODUCTS UNIQUE AND TIMELESS.

OUR DESIGN TEAM IS EXPERIENCED AND TALENTED STAFF AND THEIR WORK IN CONJUNCTION WITH HIGH QUALITY MATERIALS SUPPLIED BY RENOWNED MANUFACTURERS AND THE USE OF MODERN MACHINES, MAKES PENT.®

PENT. HAS EVERYTHING AN EXCLUSIVE HOME AND A PERSONAL STUDIO SHOULD HAVE - PERFECT ANGLE, CURVE AND EXCLUSIVE STAINLESS STEEL FINISH, THE OILED WALNUT PROVIDES A FIRM GRIP AND IS VERY HYGIENIC, WITH NO HARMFUL SUBSTANCES BEING PASSED ON TO THE USER WHEN THEY PERSPIRE.

PENT. LUXURY ACCESSORIES ARE DEDICATED TO INDIVIDUAL USE IN A PRIVATE HOME GYM AND TRAINERS IN A PERSONAL FITNESS STUDIO BUT YOU CAN ALSO USE THEM TO GREAT EFFECT IN LUXURY SPA AND A HOTEL GYM AS WELL.

ALL THE ELEMENTS COMPLEMENT ONE ANOTHER TO MAKE A UNIQUE SET ADDRESSED TO THE MOST DEMANDING CUSTOMER..



SAY HELLO.

ASK FOR OUR AMAZING PRODUCTS.

PENT. HAS ALWAYS ACCOMPANIED THOSE WHO HAD BIG DREAMS AND THE DETERMINATION TO PURSUE AND FULFILL THEM. IT IS MORE THAN A SLOGAN, IT IS A PHILOSOPHY AND WAY OF THINKING THAT COVERS ALL ACTIVITIES WHETHER IT MAY BE LARGE HOTEL CHAINS OR SMALLER PRIVATE BUT EXTREMELY PROFESSIONAL BOUTIQUE HOTELS.



*Designed by our best
designers.*

CREATED FOR A CHANGING
WORLD. CREATED FROM
THE NEED TO BE FIT IN ALL
CONDITIONS.

FIND OUT MORE ON WWW.PENTFITNESS.COM



P E N T . E X P L O R E O U R P R O D U C T S .





More than fitness.

FIND OUR PROJECTS : WWW.PENTFITNESS.COM



Fitness on the highest level

FIND OUR PROJECTS : WWW.PENTFITNESS.COM



COLMIA™

DUMBBELLS

*A whole new look
on a whole new level.*



COLMIA™ LUXURY DUMBBELLS SET

A manually crafted set made of the highest quality materials.

In the production, natural wood such as American walnut is used along with the highest grade stainless steel.

A stable construction, strong attention to detail and the heart poured into the hand-work made COLMIA™ dumbbells delightfully presentable. COLMIA™ is perfect, as a part of a modern home or a hotel gym.

Dumbbells are available in sets (horizontal or vertical) and as individual pairs (with or without a wooden stand). American oiled walnut wood provides a good grip and gives pleasure to touch. This type of wood exhibits antibacterial properties and, in combination with stainless steel creates a harmonious system of health and nature. This is very important when using these luxurious accessories in special conditions. COLMIA™ is dedicated for the private use as well as for personal trainers and gyms.



DUMBBELLS™ stand

Place your dumbbells on a solid wooden stand. Individual dumbbells are available in different weights (size depends on the weight)

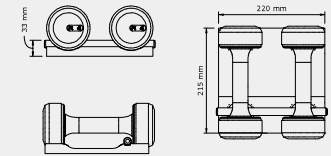

COLMIA™ Ultra Light

A set consisting of a horizontal stand and dumbbells weighing:
2 kg x 2 | 4 kg x 2 | 6 kg x 2

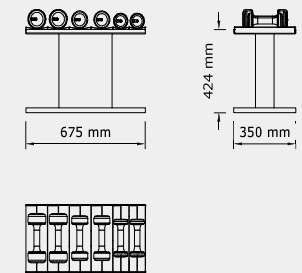

COLMIA™ Light

A set consisting of a horizontal stand and dumbbells weighing:
2 kg x 2 | 4 kg x 2 | 6 kg x 2 | 8 kg x 2 | 10 kg x 2 | 12 kg x 2

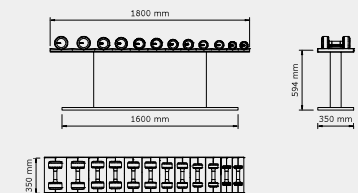



COLMIA™ Power

A set consisting of a horizontal stand and dumbbells weighing:
 14 kg x 2 | 16 kg x 2 |
 18 kg x 2 | 20 kg x 2

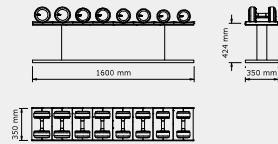

COLMIA™ VERTICAL Set

A set consisting of two vertical stands and dumbbells weighing:
 2 kg x 2 | 4 kg x 2 |
 6 kg x 2 | 8 kg x 2 |
 10 kg x 2 | 12 kg x 2 |
 14 kg x 2 | 16 kg x 2 |
 18 kg x 2 | 20 kg x 2

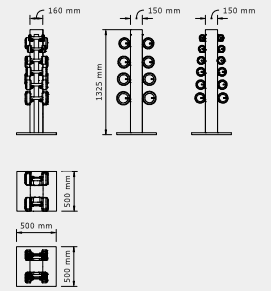

COLMIA™ Set

A set consisting of two horizontal stands and dumbbells weighing:
 2 kg x 2 | 4 kg x 2 |
 6 kg x 2 | 8 kg x 2 |
 10 kg x 2 | 12 kg x 2 |
 14 kg x 2 | 16 kg x 2 |
 18 kg x 2 | 20 kg x 2

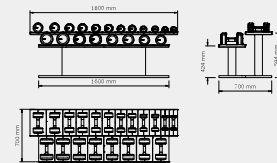

ATTENTION TO EVERY DETAIL



COLMIA VERTICAL™ Light

A set consisting of a vertical stand and dumbbells weighing:
 2 kg x 2 | 4 kg x 2 |
 6 kg x 2 | 8 kg x 2 |
 10 kg x 2 | 12 kg x 2

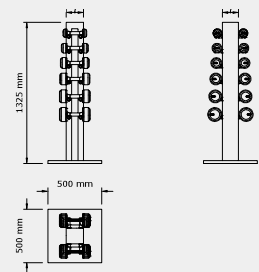

COLMIA VERTICAL™ Power

A set consisting of a vertical stand and dumbbells weighing:
 14 kg x 2 | 16 kg x 2 |
 18 kg x 2 | 20 kg x 2

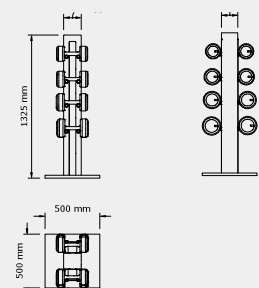

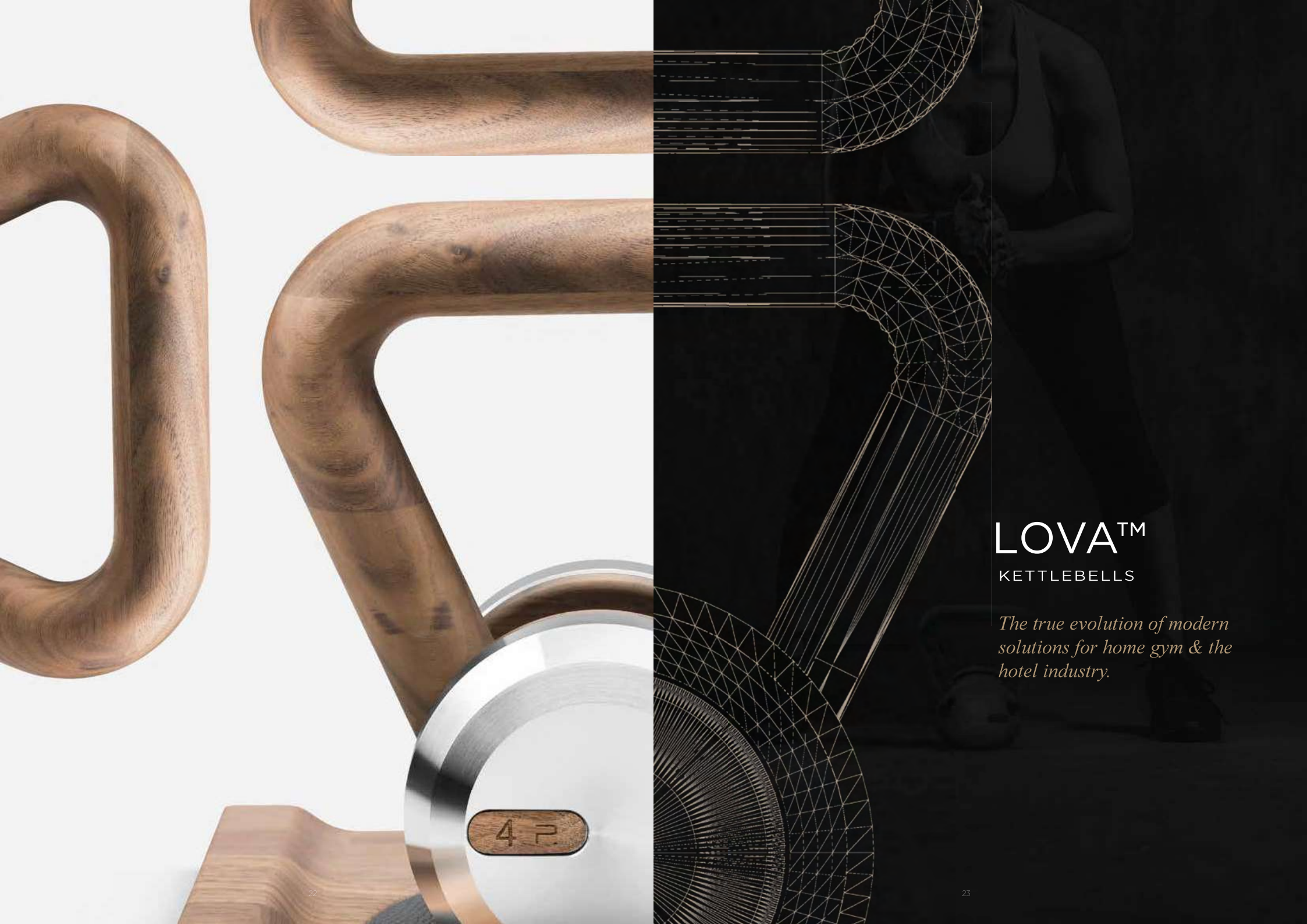

LOVA™
KETTLEBELLS

*The true evolution of modern
solutions for home gym & the
hotel industry.*



LOVA™ LUXURY KETTLEBELLS

A handmade set from natural American walnut wood and stainless steel. Just like other PENT. products, also here many hours of design work and craftsmanship have created something special in terms of form and practical use. The stable, simple stand, along with unusual form of kettlebells, create something unique which will certainly raise the prestige of the place. Each element is handmade with attention given to every detail. LOVA™ set comes in different versions. Kettlebells are available in sets (horizontal or vertical) and as individual pieces (with or without a wooden stand).

American oiled walnut wood provides a good grip and gives pleasure to touch. This type of wood exhibits antibacterial properties and, in combination with stainless steel creates a harmonious system of health and nature. This is very important when using these luxurious accessories in special conditions. COLMIA™ is dedicated for the private use as well as for personal trainers and gyms.



KETTLEBELLS Stand

Place your kettlebells on a solid wooden stand lined with genuine leather. Individual dumbbells are available in different weights (size depends on the weight)

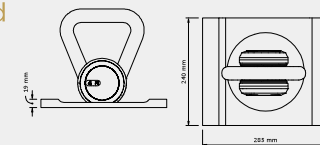

LOVA™ Light

A set consisting of a horizontal stand and dumbbells weighing:
4 kg | 6 kg | 8kg | 10 kg

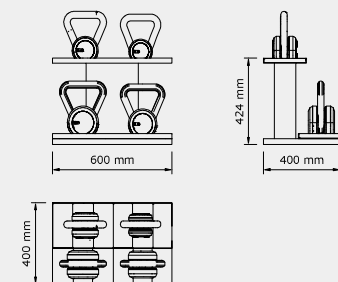

LOVA™ Power

A set consisting of a horizontal stand and dumbbells weighing:
10 kg | 12 kg | 16kg | 20kg

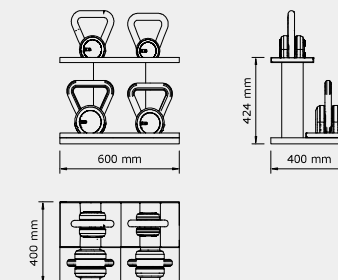



LOVA™ Set

A set consisting of a horizontal stand and dumbbells weighing:
4 kg | 6 kg | 8kg | 10 kg | 12 kg | 16 kg | 20kg

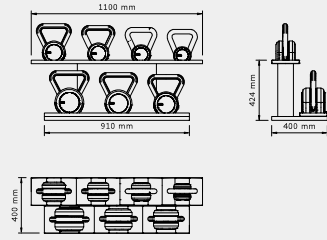

LOVA™ VERTICAL Light

A set consisting of a vertical stand and dumbbells weighing:
4 kg | 6 kg | 8kg | 10 kg

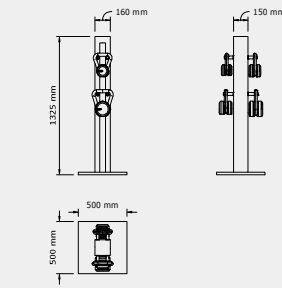

ATTENTION TO EVERY DETAIL



LOVA™ VERTICAL Power

A set consisting of a vertical stand and dumbbells weighing:
10 kg | 12 kg | 16kg | 20kg

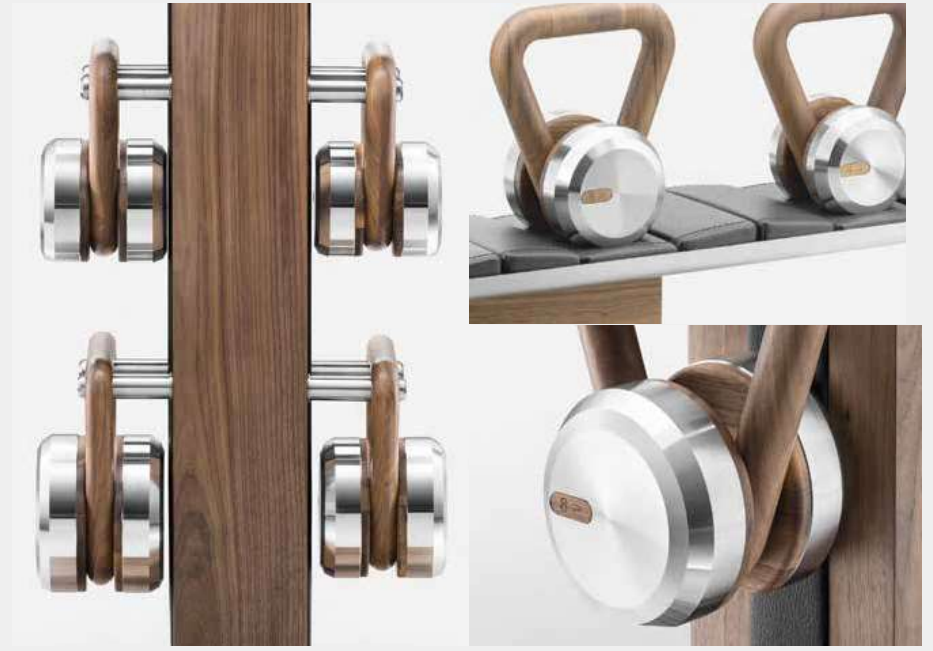
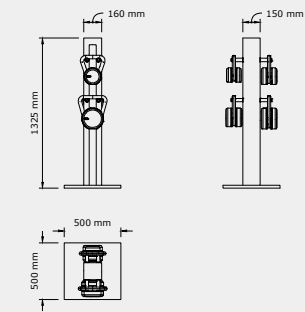

LOVA™ VERTICAL Set

A set consisting of a vertical stand and dumbbells weighing:
4 kg | 8 kg | 10 kg | 12 kg | 16 kg | 20kg

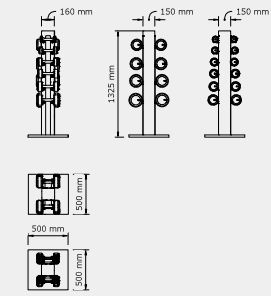

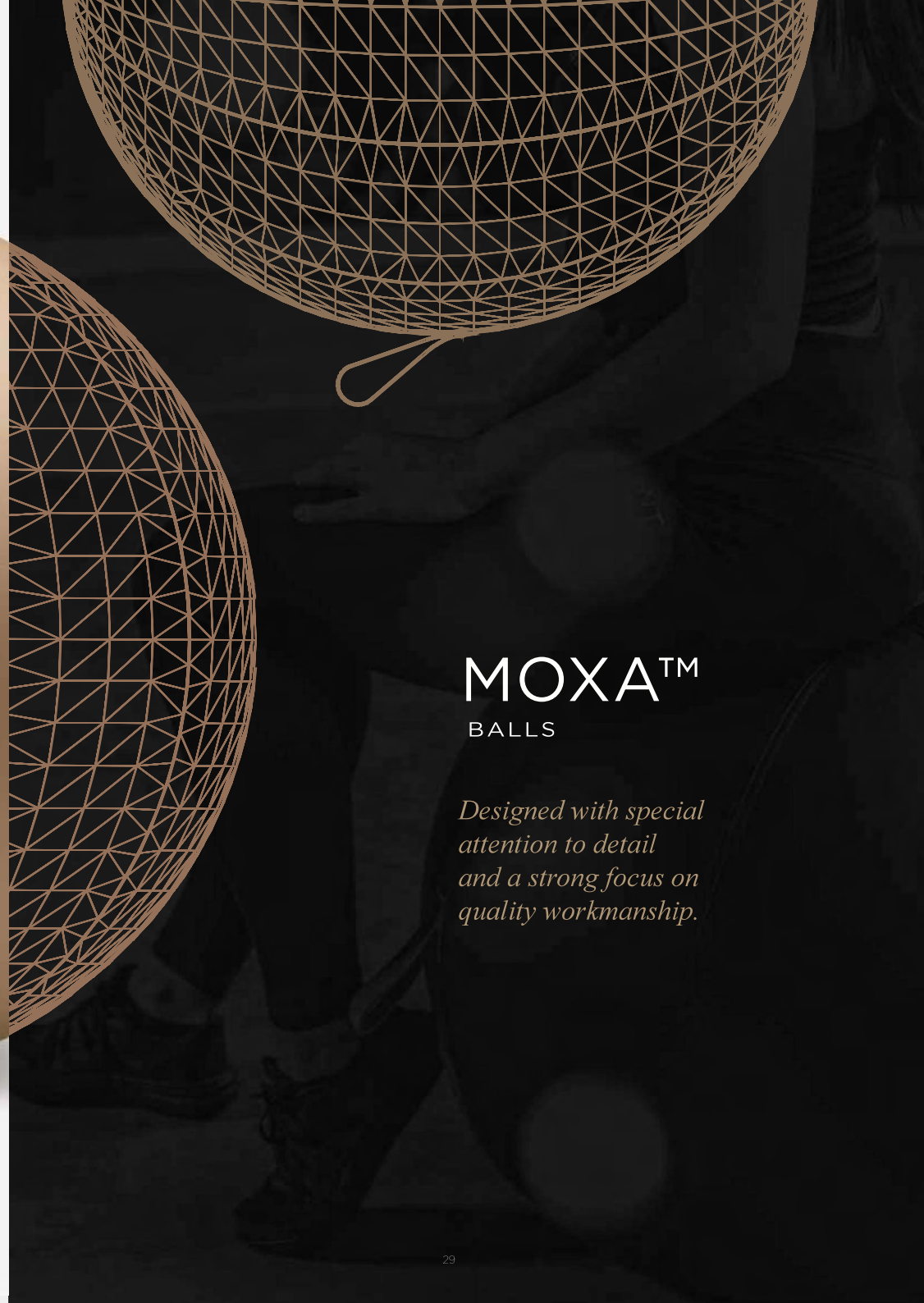

MOXA™

BALLS

Designed with special attention to detail and a strong focus on quality workmanship.



MOXA™ Light

Set consisting of a horizontal rack and leather balls weighing:
4 kg | 8 kg | 12 kg | 16 kg

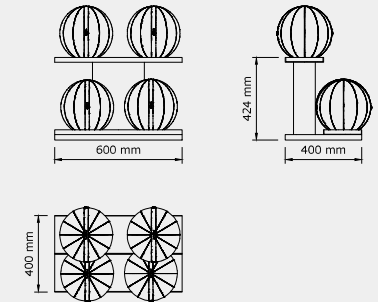

MOXA™ Power

Set consisting of a horizontal rack and leather balls weighing:
12 kg | 16 kg | 20 kg | 24 kg

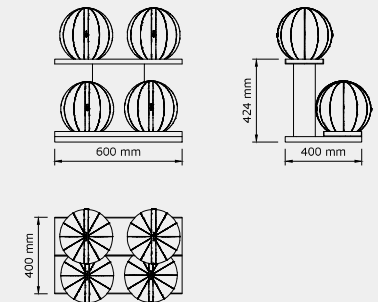

MOXA™ Set

Set consisting of a horizontal rack and leather balls weighing:
4 kg | 8 kg | 12 kg | 16 kg | 20 kg | 24 kg

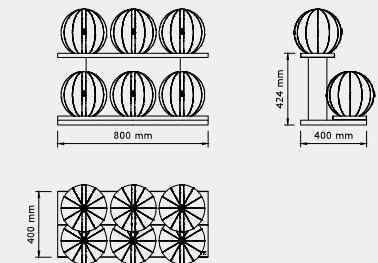

MOXA™ LUXURY BALLS

*Handmade from natural walnut wood, stainless steel and genuine leather.
Its excellent and prestigious design has a wide, practical application.
This product is our collection of a wonderful equipment for exceptional customers.*

Weighted balls are available in sets (horizontal or vertical) and as individual pieces.
Each ball has the same diameter- 25 cm..



**MOXA™
VERTICAL Light**

Set consisting of a vertical
rack and leather balls
weighing:
4 kg | 8 kg |
12 kg | 16kg

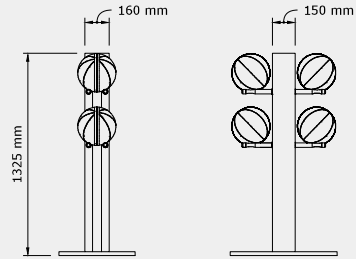

**MOXA™
VERTICAL Power**

Set consisting of a vertical
rack and leather balls
weighing:
12 kg | 16 kg |
20 kg | 24 kg

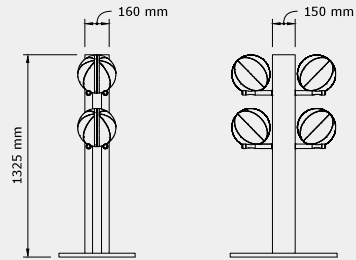

ATTENTION TO EVERY DETAIL



**MOXA™
VERTICAL Set**

Set consisting of
a vertical rack and
leather balls weighing:
4 kg | 8 kg | 12 kg |
16 kg | 20 kg | 24 kg

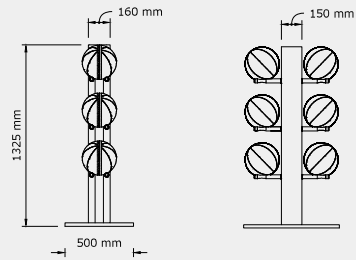



LESNA™

BARBELL SET

*A barbell set is one-of-a-kind
exercise equipment you can't do
without in any serious gym.*



LESNA™ LUXURY BARBELL SET

A handmade weight set with a bar made of the best luxury materials. The stylish and simple form of the stand is perfectly matched to the available weights. Both LESNA™ and BYSTRA™ perfectly complement our entire collection. As always, in all our products, it is entirely made of the best materials and with attention to every detail.

Hours of handmade work make the sets refined in every aspect, delighting everyone who has the opportunity to see it with their own eyes. They are ideal for a home or a hotel gym.



LESNA™

A set consisting of a stand, a barbell and weights:
4 kg x 2 | 8 kg x 2 | 12 kg x 2

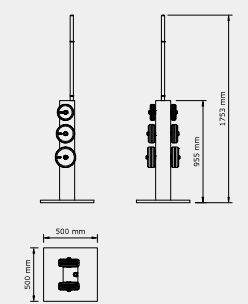

BYSTRA™

Press Bench Rack can be purchased with or without the weights
4 kg x 2 | 8 kg x 2 | 12 kg x 2

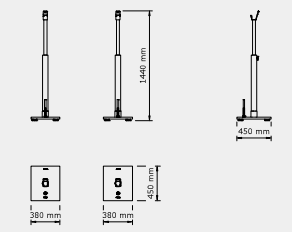

ATTENTION TO EVERY DETAIL

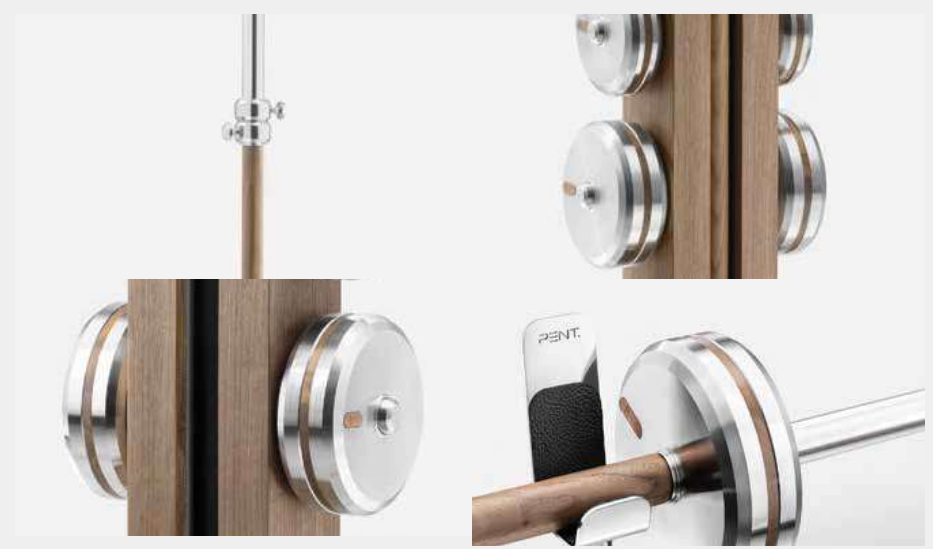



BANKA™

LUXURY FITNESS BENCH

*You might have never seen
an exercise bench like this.*



BANKA™

LUXURY FITNESS BENCH

Handmade from wood, stainless steel and natural leather. The best materials combined with the strong attention to detail make this simple exercise equipment breathtaking for anyone who is looking for a practical function with beauty and prestige for a home or a hotel gym.

BANKA™ Basic

The stable and simple form of the exercise bench stands out with its quality and craftsmanship.

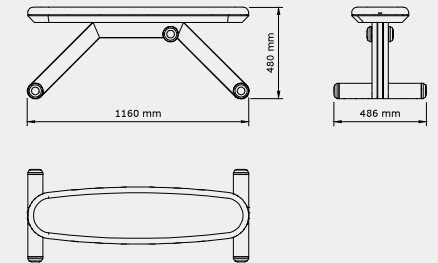

BANKA™ Advance

Wooden adjustable bench is constructed conscientiously to provide the comfort we expect, both fitting your body and weight lifting needs.

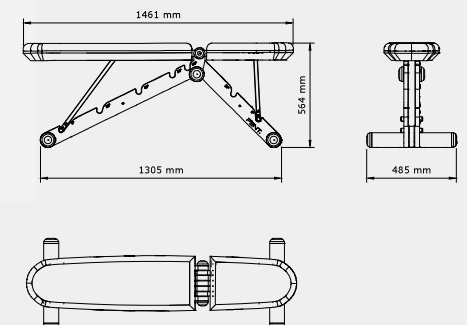



More than fitness.

FIND OUR PROJECTS : WWW.PENTFITNESS.COM

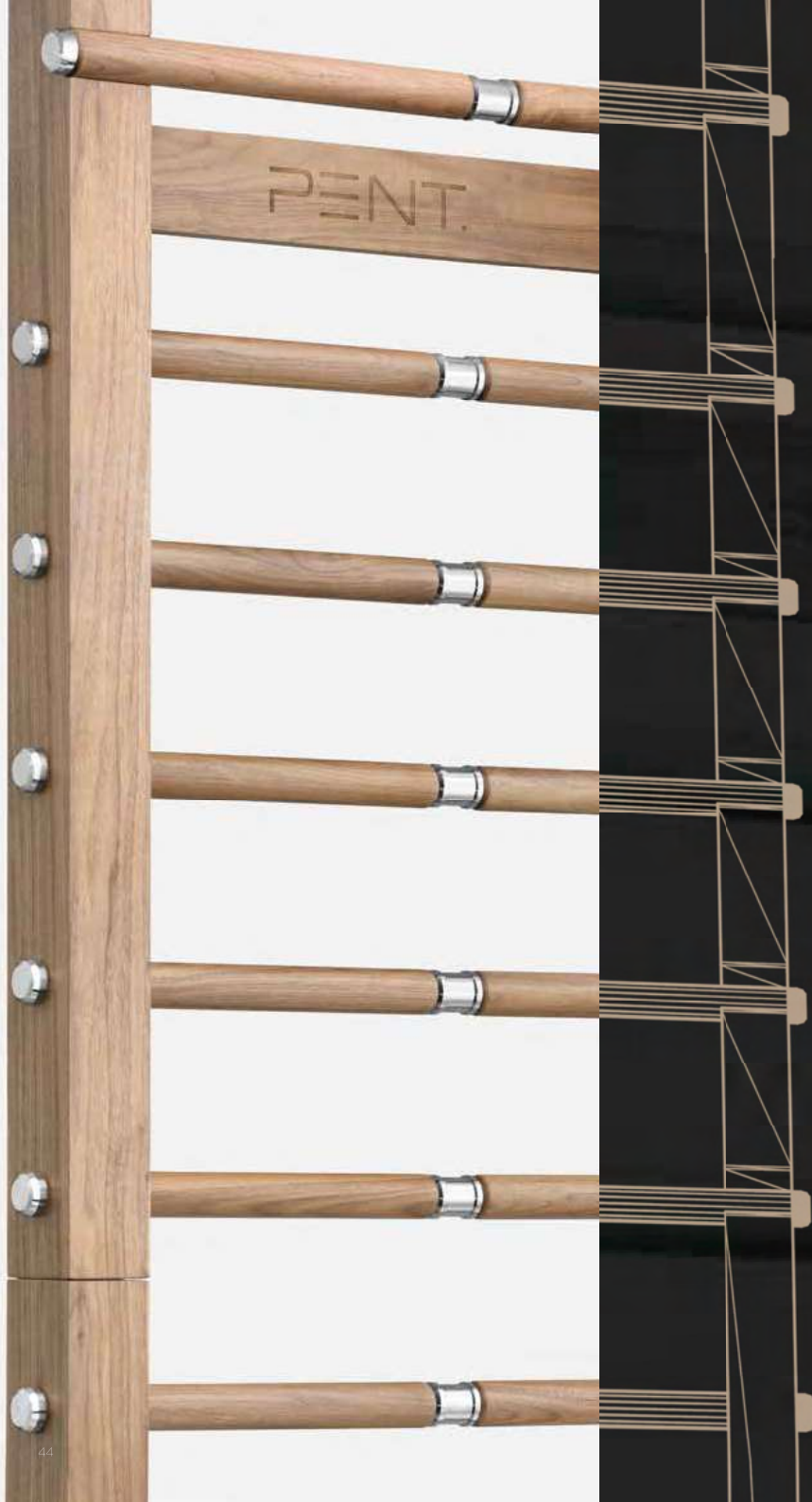

SCALA™

WALL BAR

*Power to make big things
happen in a home gym.*

SCALA™

LUXURY WALL BAR

The pattern of the ladder, referring to roots, contains a feature of weighted and removable rungs. After removing them we obtain a stylish so-called weighted „fitness bar” that is ultra soft to the touch.

The available weights range from 2 - 6 kg. To make the wall-bar even more versatile, the ladder has flexible bands that can be easily attached to the bars and the ladder. Additionally, you can also attach TRX bands (not provided).



SCALA™ Basic

Luxury wall bar for exercise. The set includes a wall-mounted frame with rungs.

Height: 243 cm

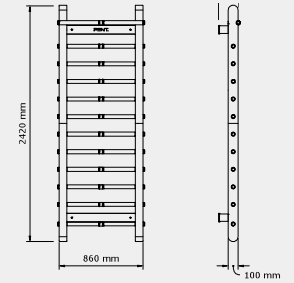

SCALA™ Advance

The wall bar, in addition that its pattern refers to roots, contains a feature of removable rungs, each with a different weight.

Height: 243 cm

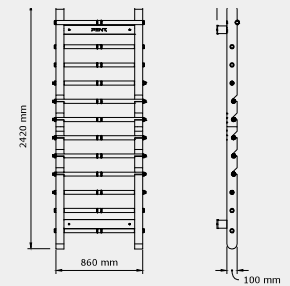

+ SCALA™ Advance

The wall bar, in addition that its pattern refers to roots, contains a feature of removable rungs, each with a different weight. With a pull-up option.

Height: 229 cm

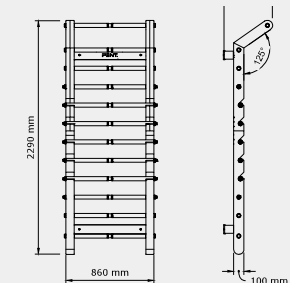

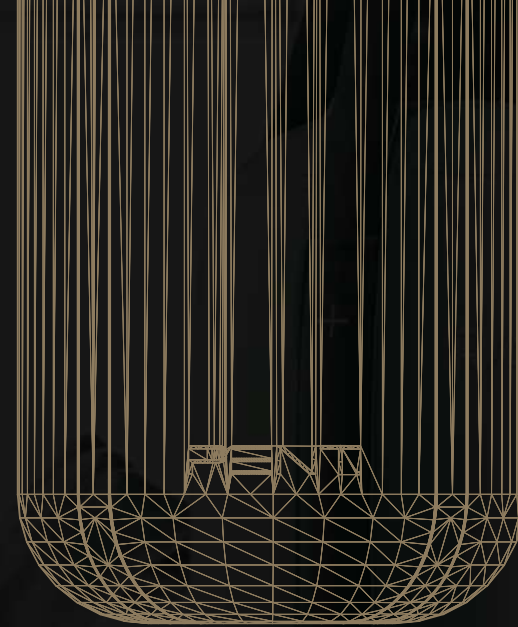

RAXA™

BOXING BAGS

Proven reliability in the most extreme conditions in home, residential or hotel gym.



RAXA™ LUXURY BOXING BAGS

Add style to your gym with this amazing genuine leather bag. It's not only beautiful to look at, it sustains heavy beating too.

It is hand-made using finest materials by dedicated craftsmen in order to make an elegant, yet practical product.



RAXA™

PENT. boxing bags have proven their reliability in the most extreme conditions in home, residential & hotel luxury gyms.

Weight: about 40 kg

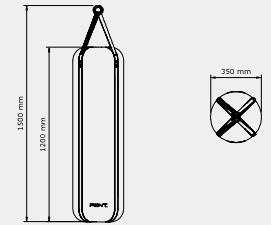

Boxing gloves for RAXA™

Thanks to the modern genuine leather design, PENT. offers the perfect combination of quality and practicality. Full Hand Made process makes this item unique & premium.

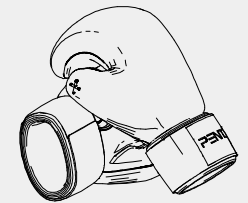

ATTENTION TO EVERY DETAIL





ACCESSORIES

Upgrade your fitness gear with PENT. Luxury fitness accessories.



LIPOVA™

Push-ups are one of the basic weight training. LIPOVA™ luxury push-up bars are an excellent way to get the most out of this exercise.

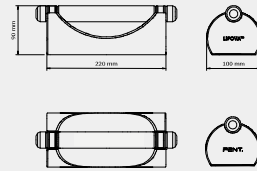

SIENNA™

One of the most fundamental fitness accessories. Simple, yet necessary. Make your fitness goals on your own terms. Length: 275 cm

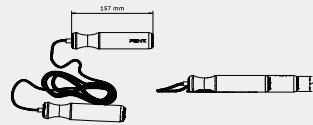

RESA™

Luxury elastic band with versatile resistance and integrated wooden grips for the highest comfort of the user. It allows to carry out strength, endurance and general development training. Length: 65 cm

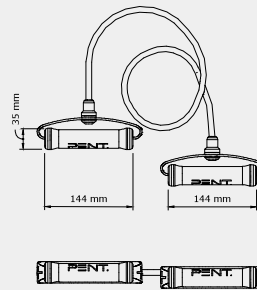

KALNA™

The bag, a.k.a the Bulgarian Bag, is made of genuine leather and has flexible handles to allow for both upper and lower body training. Filled with leather straps and sand, allows to improve your explosive actions and dynamic movements.

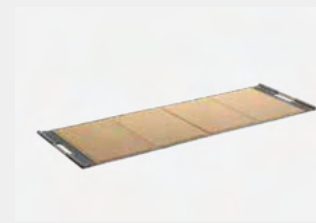
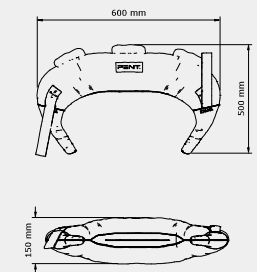

MATA™ Large

Luxury handmade leather fitness mat. It will help prevent pains in your back when you're lying down or doing cat stretches. Dimensions: 180 x 60 cm

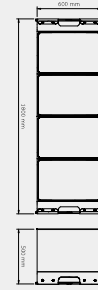

MATA™ Small

Protective leather mat, perfect for workout with dumbbells or push up bars. Dimensions: 80 x 40 cm

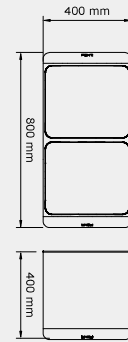

MESNA™

Exercise Sitting Ball is actually exercise equipment that can help strengthen muscles, increase balance and improve flexibility, coordination and posture. MESNA & Rest & Ball pump Diameter: 65 cm

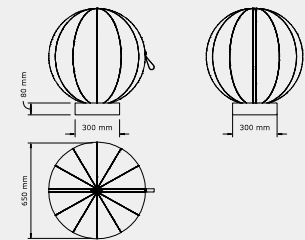

TRESNA™

Luxury Balance Trainer covered with genuine leather is the perfect tool for the combined balance and strength training. Designed to develop flexibility, stability and core strength with challenging cardio workouts. Base diameter: 65 cm Height: 35 cm

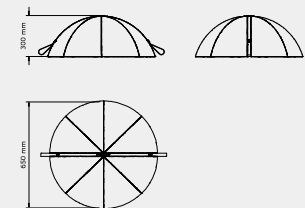

ROLA™



Luxury soft roller covered with genuine leather for self-myofascial release in which pressure is applied to certain body parts to relieve pain.
Length: 45 cm
Diameter: 15 cm

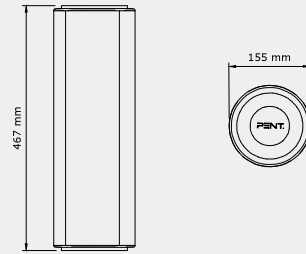

KOHA™



Luxury Yoga Block. Classic, natural wood construction, clad in natural leather gives you durability and security during workout.

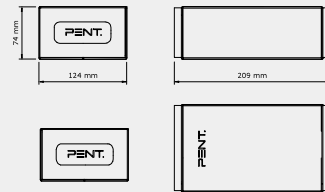

GUMA™



Flexible bands can be used for stretching, flexibility and mobility. They come in 3 different resistance levels (Light, Medium, Power) to train different muscle groups and allow for progression. Types of stretch: easy, medium, hard
Length: 75 cm

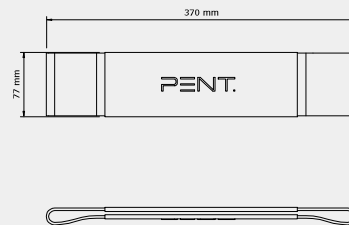

PASA™



The leather yoga belt facilitates or intensifies stretching exercises, provides more reach as an „extension“ of the arms and allows you to stay in the stretched position longer.
Available length: 160 cm or 240 cm

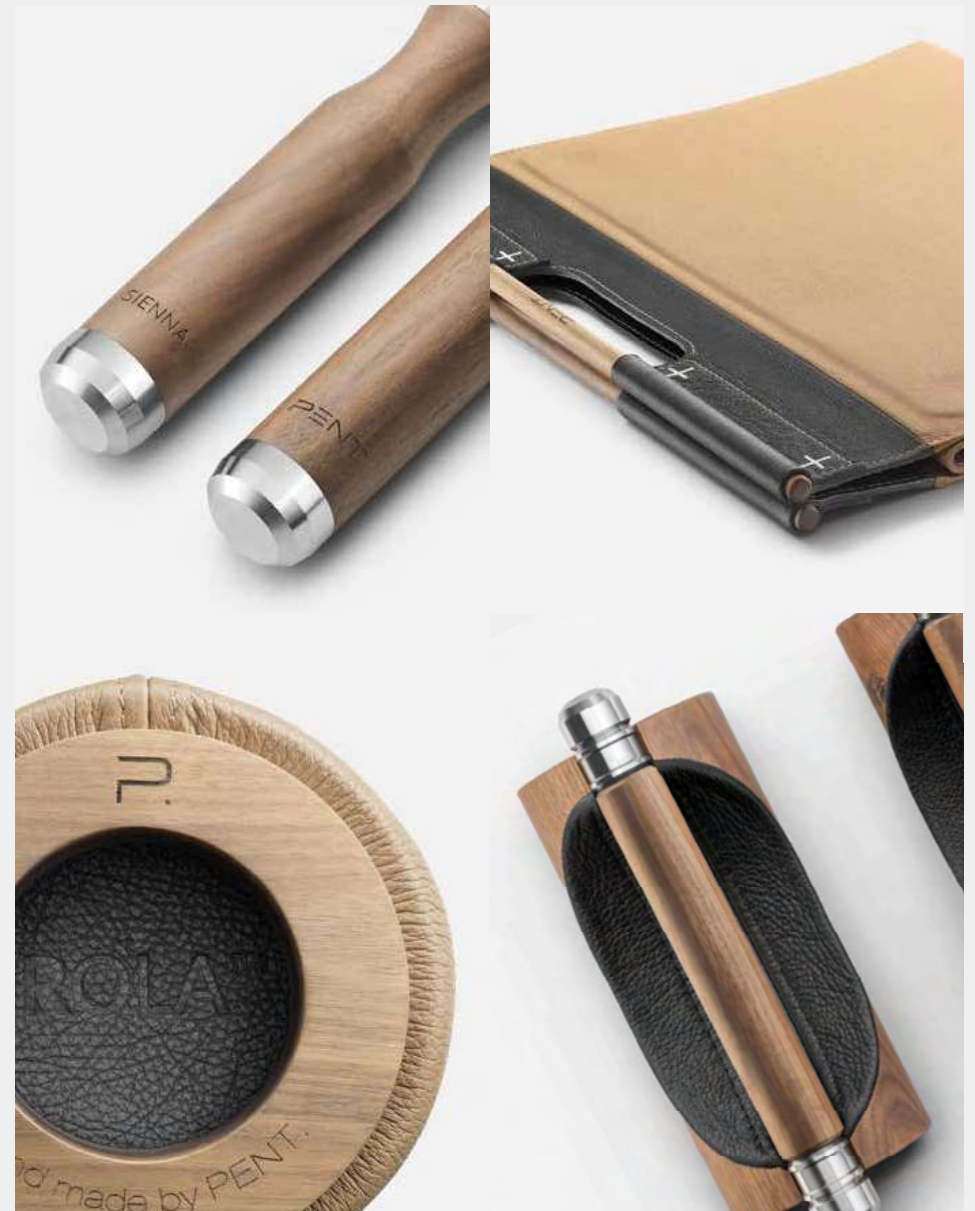
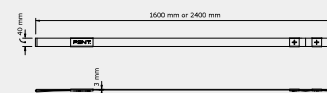



MULTI SET

Complementary set of dumbbells, kettlebells, exercise mat and essential fitness accessories.

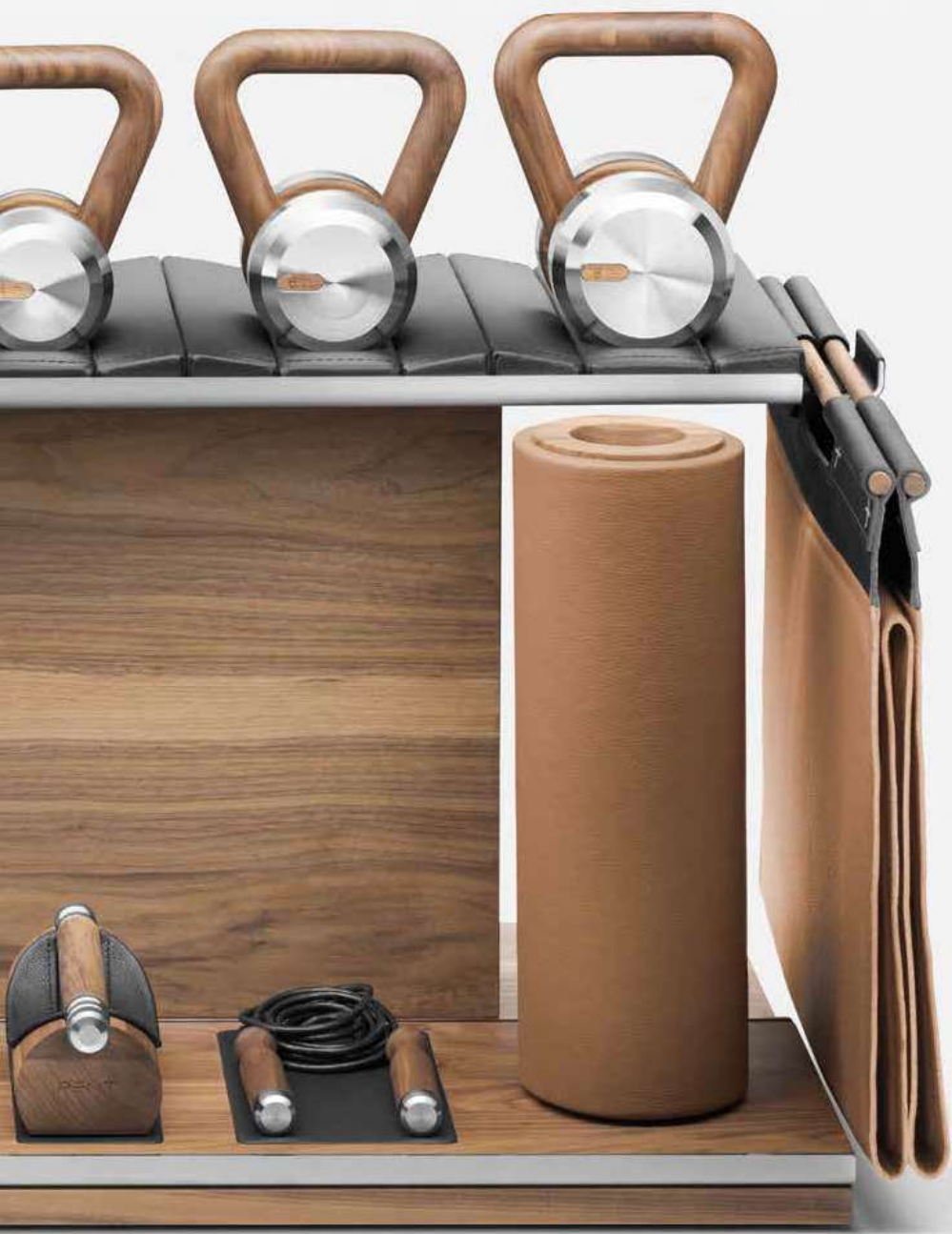

RACKA™

Beautiful rack with accessories. RACKA™ includes following products:

- LIPOVA 1 set
- MESNA 1 pc
- MATA Large 1 pc
- SIENNA 1 pc
- TRESNA 1 pc
- ROLA 1 pc

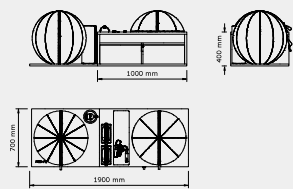

COMBO™ Ana

Created as a complete set for the most demanding people.

- COLMIA 4 kg x 2 | 6 kg x 2 | 8 kg x 2
- LOVA 4 kg | 6 kg | 8 kg
- MOXA 4 kg | 8 kg
- KOHA 2 pcs
- LIPOVA 1 set
- SIENNA 1 pc
- ROLA 1 pc

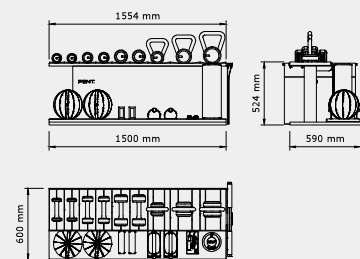

ATTENTION TO EVERY DETAIL





SOPHIA™ Mobile Gym Kit

Created as a complete set for the most demanding people. Created by specialists for professionals and enthusiasts. Complementary set of dumbbells, kettlebells, exercise mat and essential fitness accessories. The ergonomic design includes drawers for smaller but extremely important accessories such as a jump rope or a push-up device.

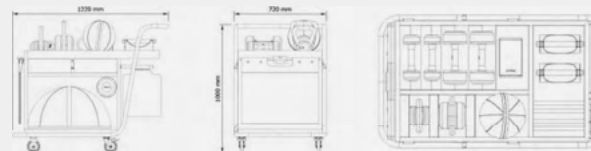

Sophia includes:
 COLMIA™ Dumbbells (pairs): 4 kg / 8 kg
 LOVA™ Kettlebells: 4 kg / 8 kg
 TRESNA™ Balance Ball
 MOXA™ Weighted Ball: 1pc 8kg
 SIENNA™ Skipping Rope
 MATA™ Exercise Fitness Mat
 LIPOVA™ Push Up Bars
 KOHA™ Yoga Block
 PASA™ Yoga Belt
 ROLA™ Stretching Roller

ATTENTION TO EVERY DETAIL





COLLECTION BLACK ASH

Ergonomic, sophisticated and timeless style, PENT.™ solution is an interpretation of timeless elegance. The combination of simple forms, curved lines and elegant proportions makes the set stand out so much that it cannot be said that it is just fitness equipment. The subtle play of light and shadow, smooth surfaces and the most precious materials will make the product impossible to ignore.

Made of the best stainless steel, walnut wood and natural leather & represents elegant styling combined with innovative

ATTENTION TO EVERY DETAIL

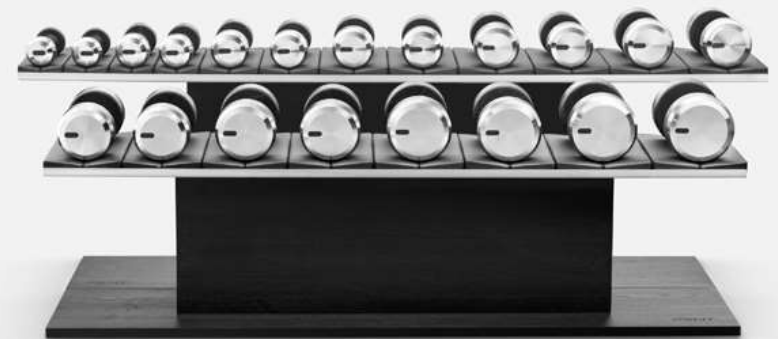

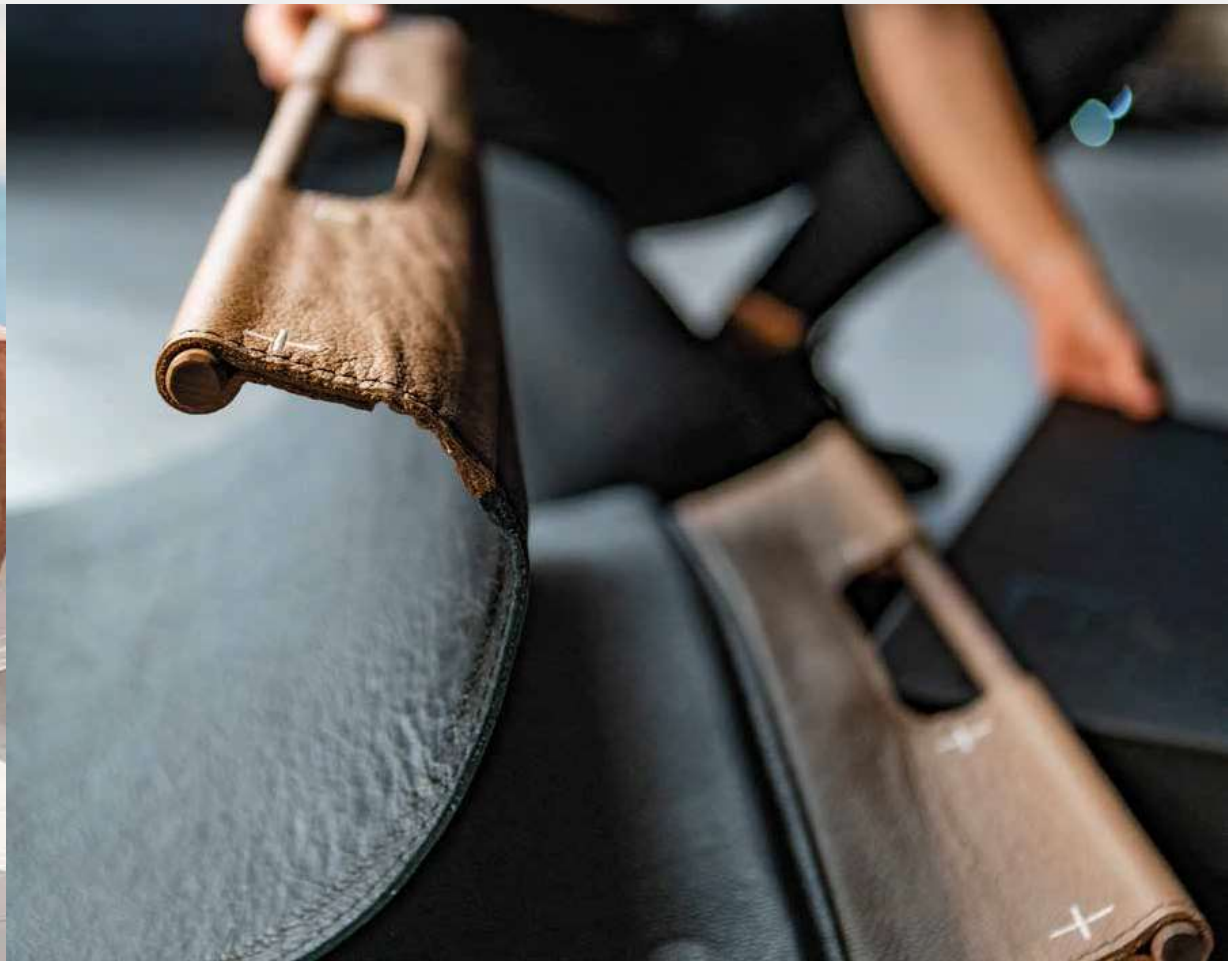

FIND OUR PROJECTS : WWW.PENTFITNESS.COM

*PENT.
The highest quality
of materials.*

HAND MADE PRODUCTS CREATED FOR INDIVIDUAL ORDERS, AND DELIVERED TO CUSTOMERS AROUND THE WORLD. EVERY PIECE OF PENT. COLLECTION CAN BE CUSTOMIZED ACCORDING TO YOUR NEEDS. YOU CAN CHANGE THE LEATHER COLOR AND SELECT THE TYPE OF WOOD. THE CUSTOM PIECE WILL BE MANUFACTURED ACCORDINGLY.

EVERY PIECE OF PENT IS MADE-TO-ORDER FROM START TO FINISH BY OUR QUALIFIED CRAFTSMAN. PERSONALIZED ITEMS ARE MADE IN LIMITED QUANTITIES FROM DURABLE FABRICS, MAKING EACH ITEM EXCEPTIONAL

W O O D

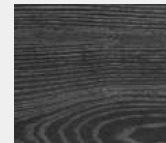

BLACK ASH



ASH

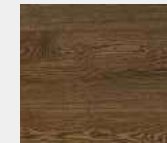

ASH WALNUT

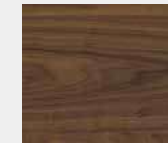

WALNUT



DARK WALNUT

M E T A L



STAINLESS

G E N U I N E L E A T H E R

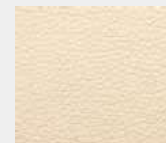

BEIGE

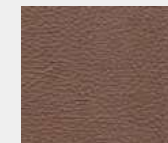

BROWN

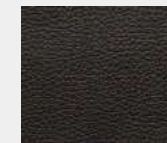

BLACK



GREY

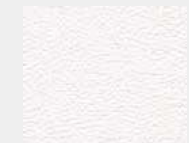

WHITE



SAMPLE BOX

You will be able to touch all materials and choose the best for you. Thanks to the Sample Box you will be able to make a decision on the best color version of your project.

T A K E N O T E S



*PENT. is writing its future...
and the future of fitness
equipment making.*